



CADENA







# SPOTLIGHTS



## Spots

12V / GU 5,3 / QR-CBC 51 max. 50W

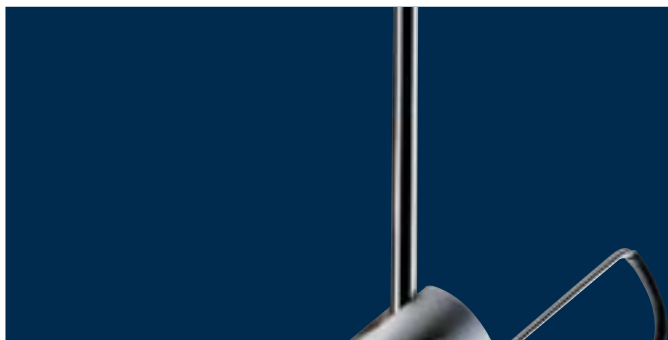
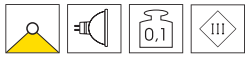

⇒ 4

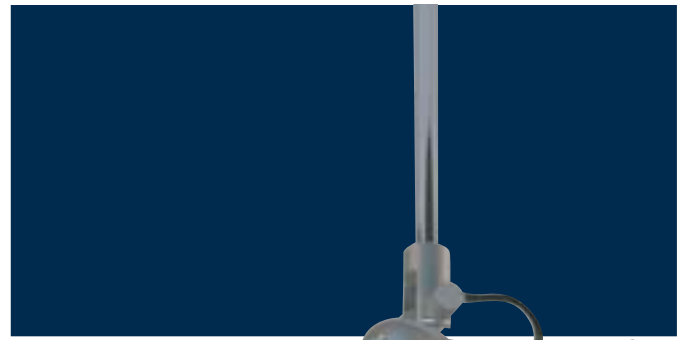

⇒ 7a

MX-2 - CD

9-80008

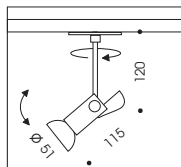

ROXAN - CD

9-80808

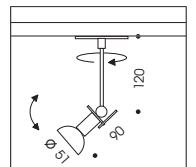



⇒ 4



⇒ 7a

MILAN - CD

12V / GU 5,3 / QR-CBC 51 max. 50W

9-80409

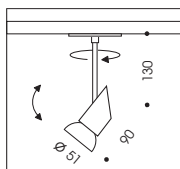

TEC - CD

12V / GY 6,35 / QT-LP 12 max. 50W/m

9-80308  
9-80309

C  
CM

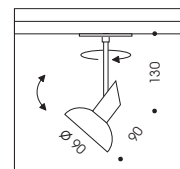

SPOTLIGHTS



LP 111 - CD

12V / G 53 / QR-LP 111 max. 75W

9-80908

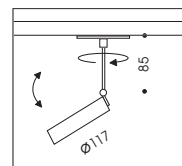

## SPOTLIGHTS / FLOODLIGHTS

### ALUETTE - CD

12V / GY 6,35 / QT-LP 12 max. 50W/m  
GU 5,3 / QR-C 51 max. 50W

9-81008

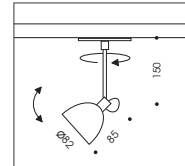
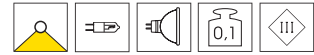

### NIGHT FLIGHT - CD

12V / GY 6,35 / QT-LP 12 max. 50W

9-81108

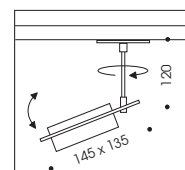

# FLOODLIGHTS



## Floodlights

12 V / G 4 / QT-LP 9 max. 20W



MAGIC - CD

9-80179

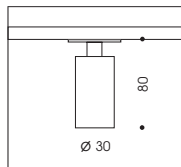

TRIM - CD

9-84139

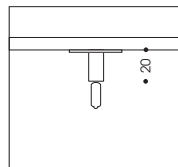

SALLY - CD

9-80173  
9-80170

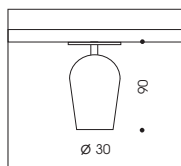

SPIN - CD

9-80012

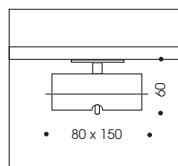

# PLUG-IN LIGHTS



PLUG-IN - CD

12V / 10A

9-84057



▷ PLUG-IN Lights



Zubehör / Accessoires / Toebehorende  
Accessories / Accessori / Accesorios

 12 V / max. 25 A

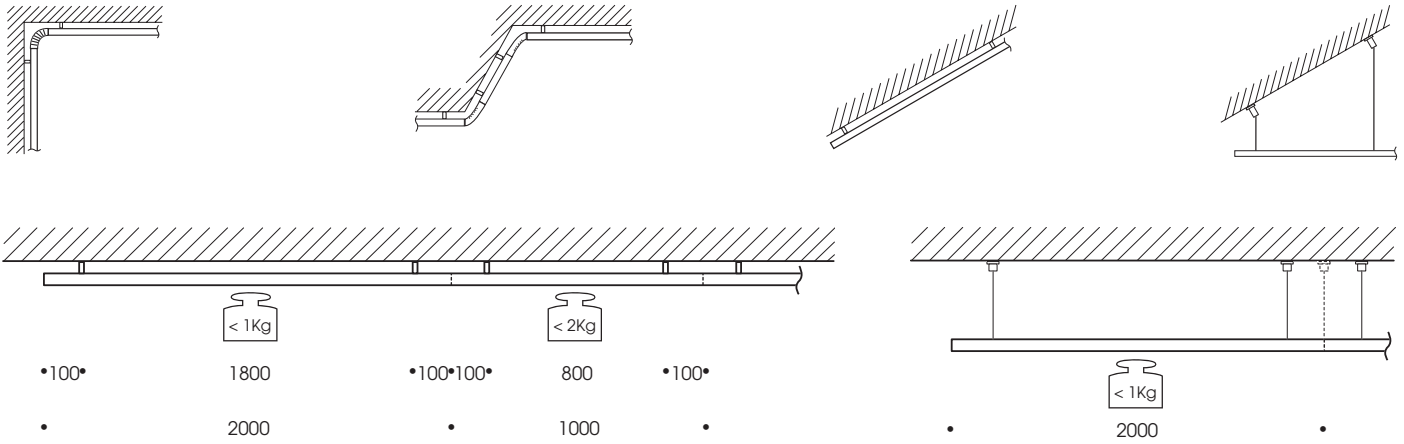

## 1. Schiene / Rail / Stroomrail Track / Binario / Guía

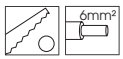

- 1.1 9-84001 CM  $\varnothing 24 \times 1000\text{mm}$
- 1.2 9-84005 CM  $\varnothing 24 \times 2000\text{mm}$

 2 x No. 2

## 2. Träger / Support / Drager Support / Supporto / Soporte

### 2.1 $\varnothing 10 \times 30\text{mm}$

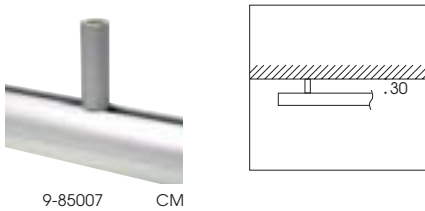

9-85007 CM

### 2.2 1500mm

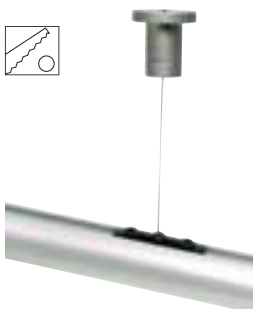

9-84045 CM

## 3. Kupplung / Raccord / Koppeling Coupler / Raccordo / Acoplamiento

### 3.1



9-80025

### 3.2



9-80029

### 3.3 90°



9-84033 CM  $\varnothing 24\text{mm}$

### 3.4 $\varnothing 24 \times 325\text{mm}$



9-83037 B

## 4. Endstück / Embout de fermeture / Eindstuk End cap / Terminale / Pieza terminal



9-84021 CM  $\varnothing 24\text{mm}$

## 5. Abdeckprofil / Profil couverture / Afdekprofiel Cover profile / Perfilo cobertura / Perfil de cubierta



9-84009 CM 1000mm

## 6. Einspeisung / Alimentation / Voeding Supply connector / Alimentatore / Alimentación

### 6.1 $\varnothing 24 \times 70\text{mm}$

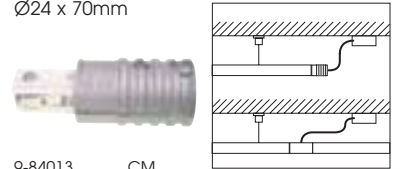

9-84013 CM

### 6.2 $\varnothing 24 \times 125\text{mm}$



9-84017 CM

### 6.3 Kabel / Cables / Kabels Cables / Cavi / Cables

9-80024 6mm<sup>2</sup> / 500mm

## 7. Einspeisung / Alimentation / Voeding Supply connector / Alimentatore / Alimentación

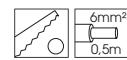

9-45087 C  $\varnothing 70 \times 24\text{mm}$   
9-45087M CM

 No. 6.1 / 6.2

Transformator / Transformateur / Transformator  
 Transformer / Trasformatore / Transformador

 230 V / 50/60Hz / 12 V

8. AIR-BASE

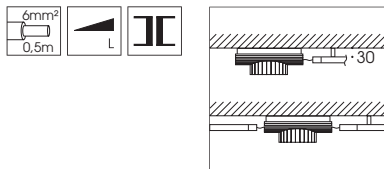

200VA  
 1-12001 CM 250 x 240 x 73mm

300VA  
 1-12007 CM

300VA-CONTROL  
 1-12013 CM



6.1

9. PYRAMID

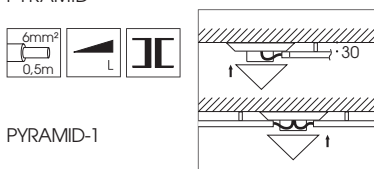

9.1 PYRAMID-1

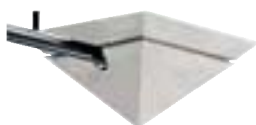

200VA  
 1-98004 CM 245 x 245 x 130mm

300VA  
 1-98010 CM

300VA-CONTROL  
 1-98022 CM

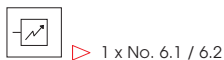

9.2 PYRAMID-2



200VA  
 1-98084 CM 245 x 245 x 130mm

300VA  
 1-98076 CM

300VA-CONTROL  
 1-98016 CM



9.3 PYRAMID-3



200VA  
 1-11084 CM 245 x 245 x 130mm

300VA  
 1-11076 CM

300VA-CONTROL  
 1-19305 CM

▶ 1 x No. 6.1 / 6.2

10. TRANSFORMER 200/300

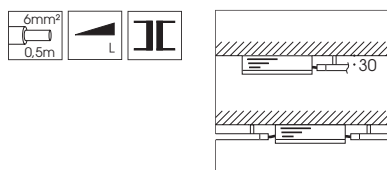

200VA  
 1-15134 C 227 x 83 x 61mm  
 1-15165 CM  
 1-15132 W

300VA  
 1-15003 C 297 x 83 x 61mm  
 1-15007 CM  
 1-15001 W

300VA-CONTROL  
 1-15049 C 297 x 83 x 61mm  
 1-15051 CM  
 1-15047 W

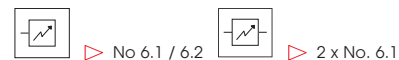

11. CHARGE-1

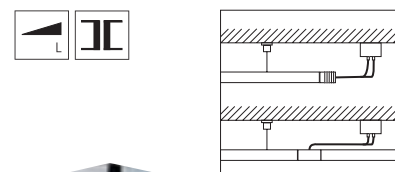

105VA  
 1-10057 C Ø120 x 57 / 77mm  
 1-10057M CM

200VA  
 1-10059 C Ø140 x 72 / 93mm  
 1-10059M CM  
 1-10059G G

300VA  
 1-10061 C Ø140 x 72 / 93mm  
 1-10061M CM  
 1-10061G G

300VA-CONTROL  
 1-10080 C Ø140 x 85 / 107mm  
 1-10082 CM  
 1-10084 G

▶ No. 6.3 + 6.1 / 6.2

12. CHARGE-2

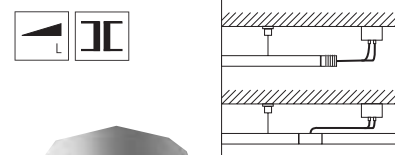

105VA  
 1-11051 W Ø115 x 53 / 73mm

200VA  
1-11053 W Ø127 x 65 / 85mm

300VA  
1-11055 W Ø148 x 65 / 85mm

300VA-CONTROL  
1-31055 W Ø148 x 89 / 107mm

▷ No. 6.3 + 6.1 / 6.2

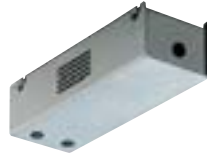

150VA  
1-12029 C 210 x 75 x 54mm  
1-12027 CM

### 13. TRANSFORMER 150

